

BED SIDE MOLLE

2022-2023/TOYOTA TUNDRA

R2200TTUNBSM

DRIVER

R2200TTUNBSM-D

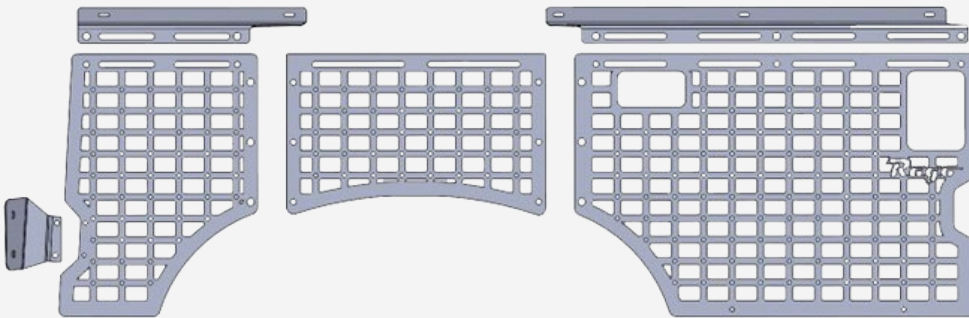

PASSENGER

R2200TTUNBSM-P

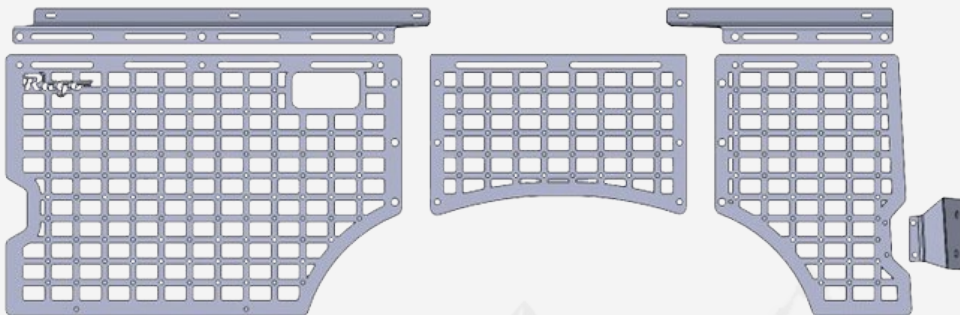

TOOLS REQUIRED

- 7/16 socket
- 9/16 wrench
- 7/32 Hex
- T30 Torx
- Uni-bit
- Drill
- Rivet Nut Tool



SKILL LEVEL

- Easy



TIME REQUIRED

- Approximately 1 Hour

⚠ WARNINGS/CAUTIONS BEFORE STARTING INSTALLATION ⚠

-BEFORE YOU INSTALL THIS KIT-

Read and understand all instructions, warnings, cautions, & notes contained in this installation instruction guide. Consult your vehicle owner's manual for proper disconnection of electrical and lifting of vehicle if required for installation of this product.

This install may require some technical skills and knowledge of basic mechanical work. If you do not feel that you are capable of performing this install please take this product to a trained professional.

After reading this guide please contact us with any questions or concerns before installing product.

Customer Service: 830-896-7571

Rago Fabrication is not responsible for any bodily injury or harm to you or your vehicle as a result of an improper install.

Proper installation of this kit required knowledge of the factory recommended procedures for removal and installation of original equipment components.

We recommend that the factory shop manual and any special tools needed to service your vehicle be on hand during the installation. Installation of this kit without proper knowledge of the factory recommended procedures may affect the

performance of these components and the safety of the vehicle.

Inspect all contents of this package to make sure product is not damaged and all installation hardware has been included. If parts are missing from kit, please be prepared to provide the following information:

1. Name of purchase location
2. Bar Code on side of box
3. Date above bar code
4. Date inside box cover

ALWAYS WEAR EYE PROTECTION WHEN OPERATING POWER TOOLS

HARDWARE

A.

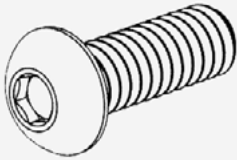

1/4-20 X 3/4" BUTTON HEAD

QTY: 2

A1.

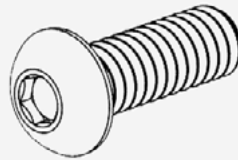

1/4-20 X 1 1/4" BUTTON HEAD

QTY: 2

A2.



1/4" FLAT WASHER

QTY: 4

A3.

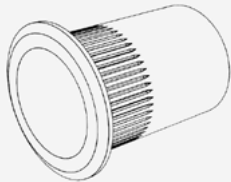

1/4-20 Rivet Nut

QTY: 2

B.



1/4" Plastic Spacer

QTY: 2

C.

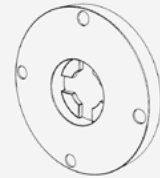

1/4" Self-Retaining Washer

QTY: 2

D.

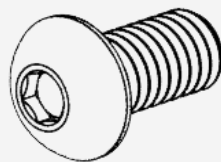

3/8-16 X 3/4" BUTTON HEAD

QTY: 11

D1.



3/8" FLAT WASHER

QTY: 11

Reference this page throughout the install



□ STEP 1

Remove the OEM hardware for the bed side rails using a (T30 Torx).



□ STEP 2

Slide the mounting brackets behind the bed side rails and re-install OEM hardware using a (T30 Torx).

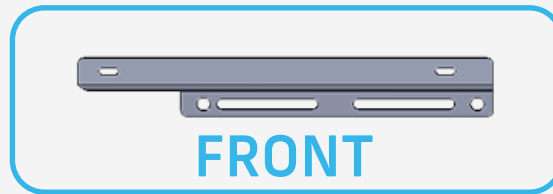
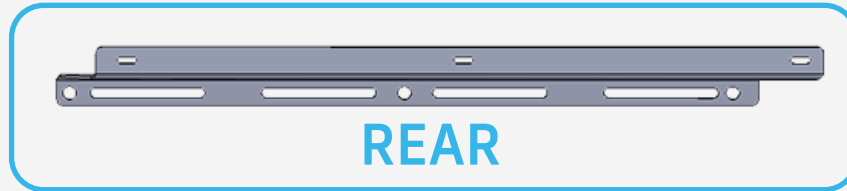

□ STEP 3

Remove the tie down hook OEM hardware using a (T30 Torx).

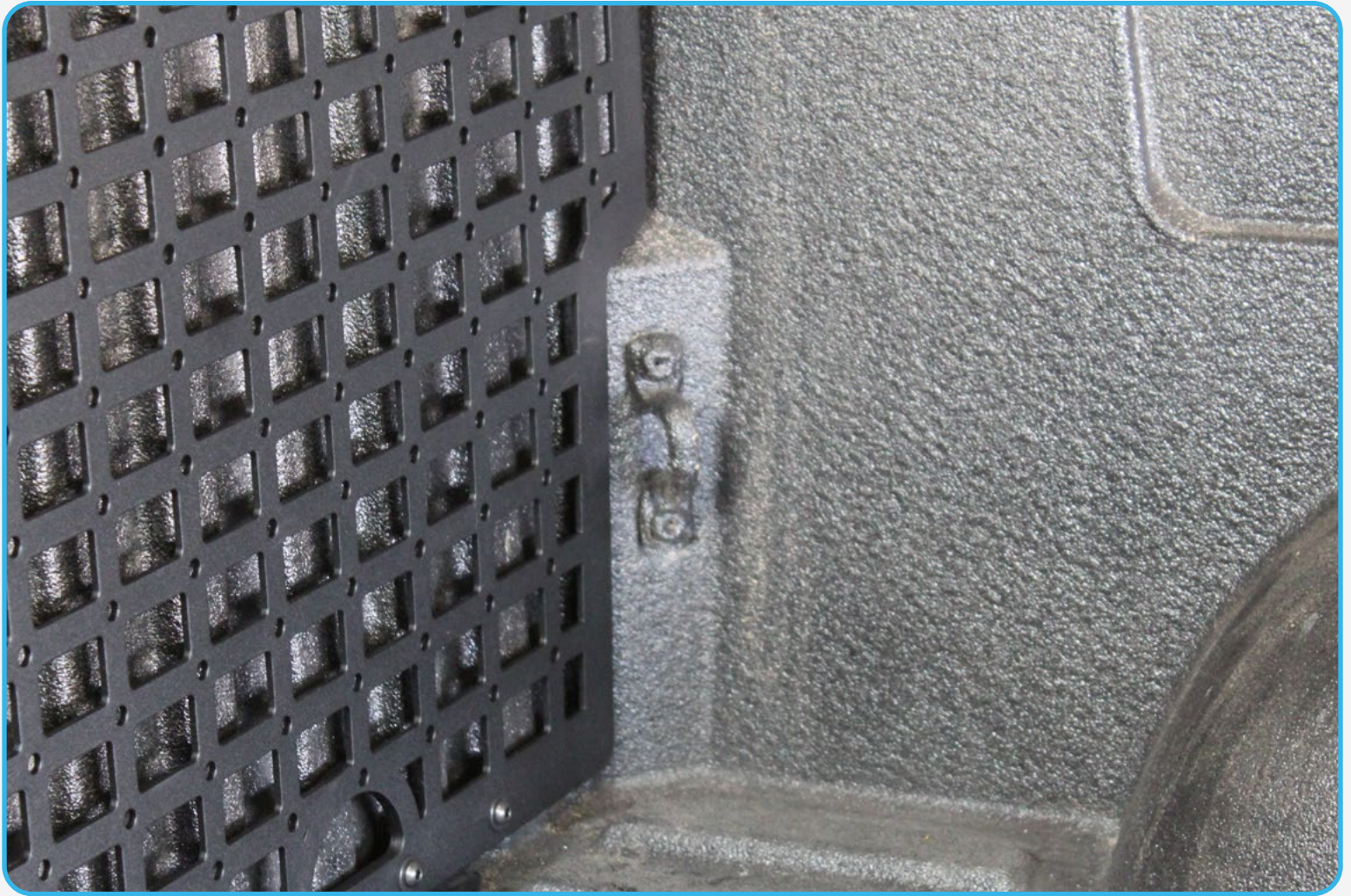

□ STEP 4

Install the mounting bracket **WITH** or **WITHOUT** the tie down hook with the OEM hardware using a (T30 Torx).

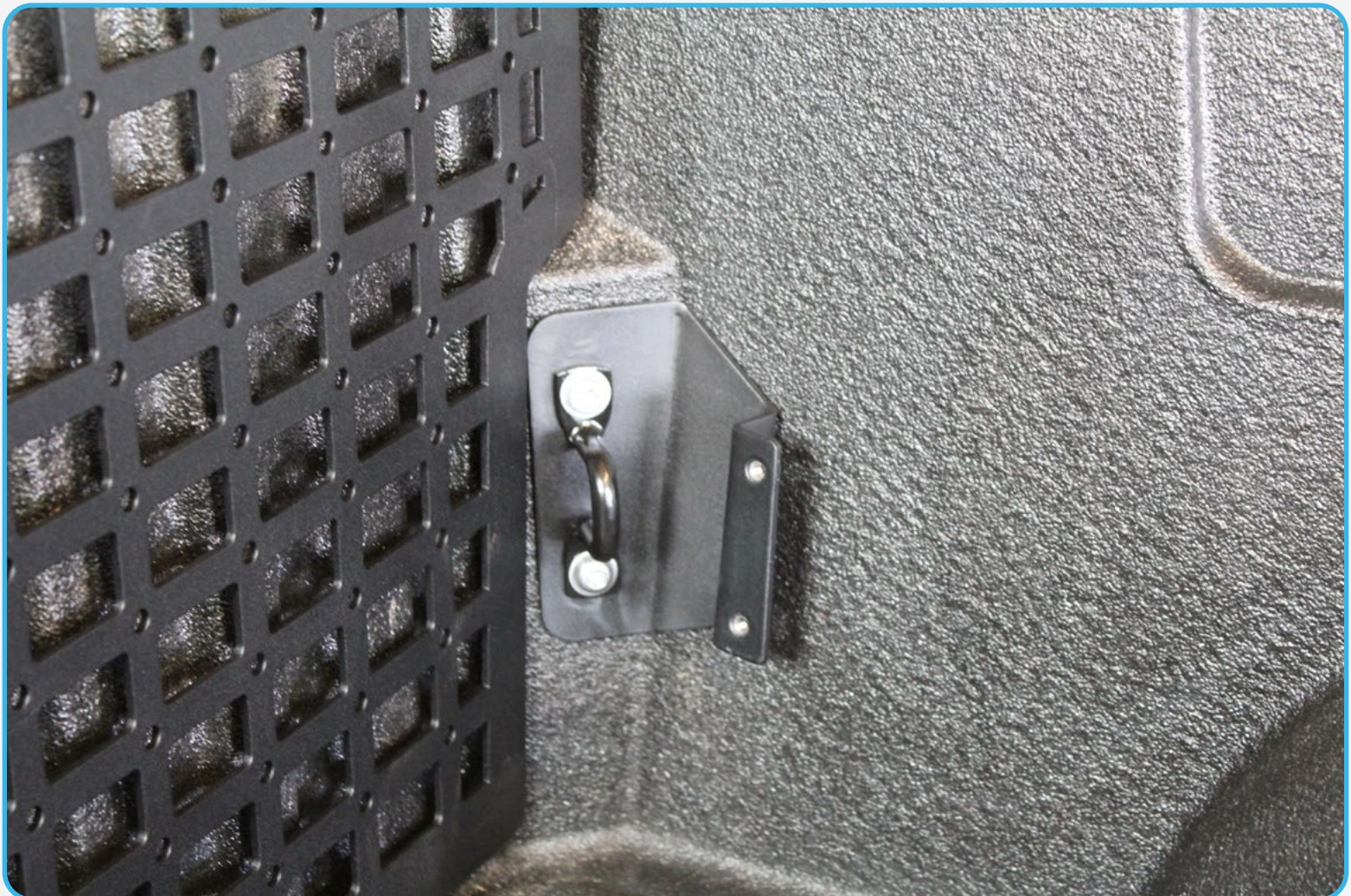
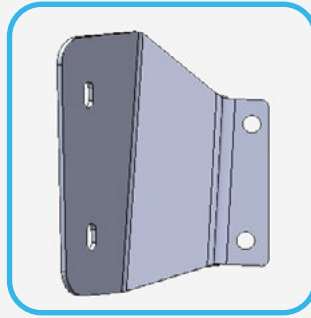

STEP 5

Install the front molle to the mounting bracket installed in step 4 with the provided hardware (**A, A2**) using a (**5/32 Hex**).

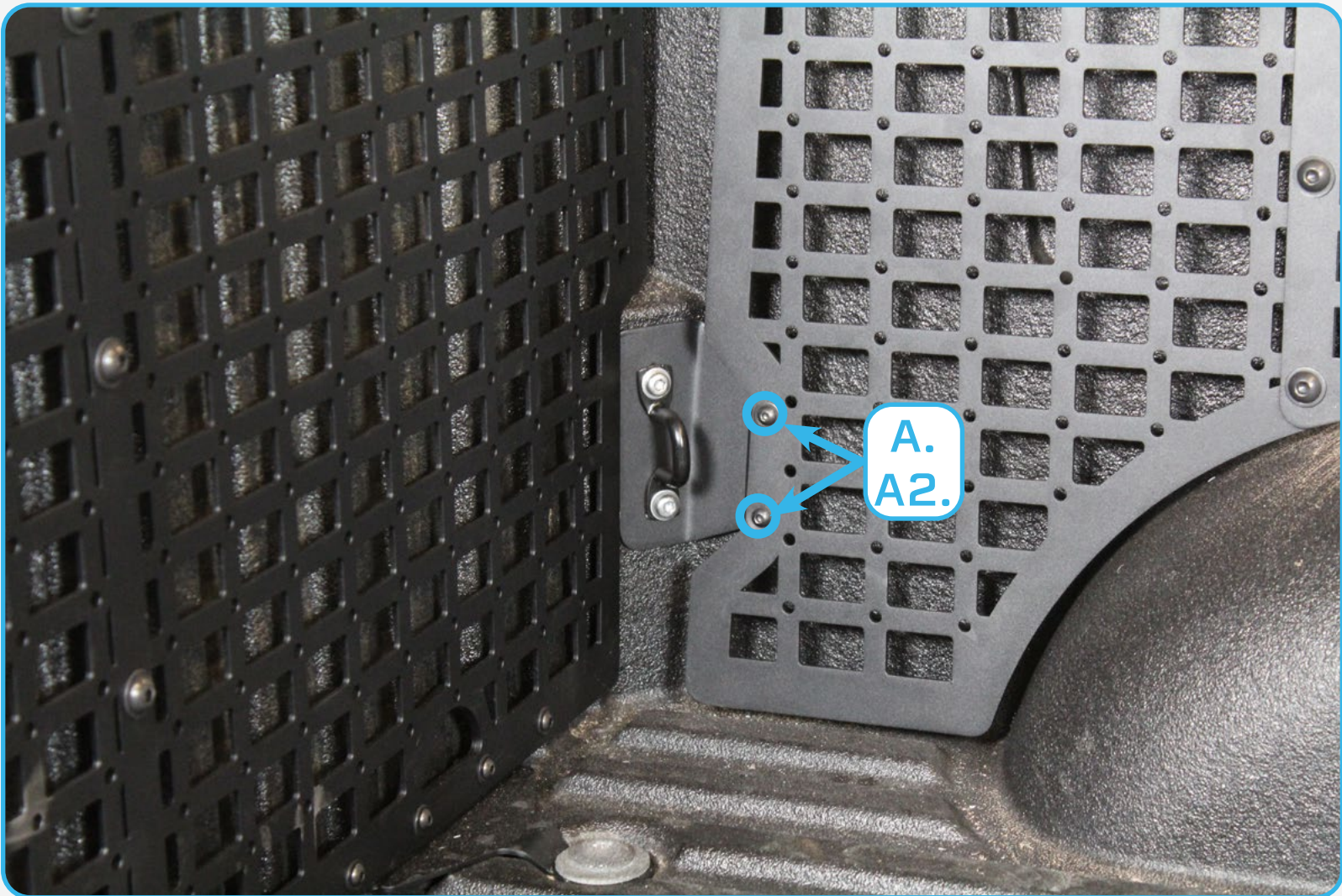
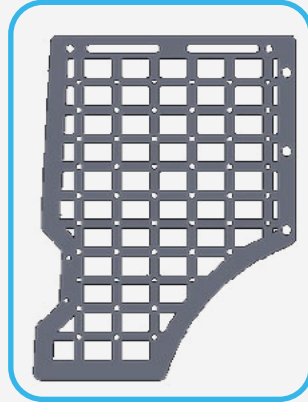

STEP 6

Install the middle molle with the provided hardware (**C, C1**) using a (7/32 Hex).

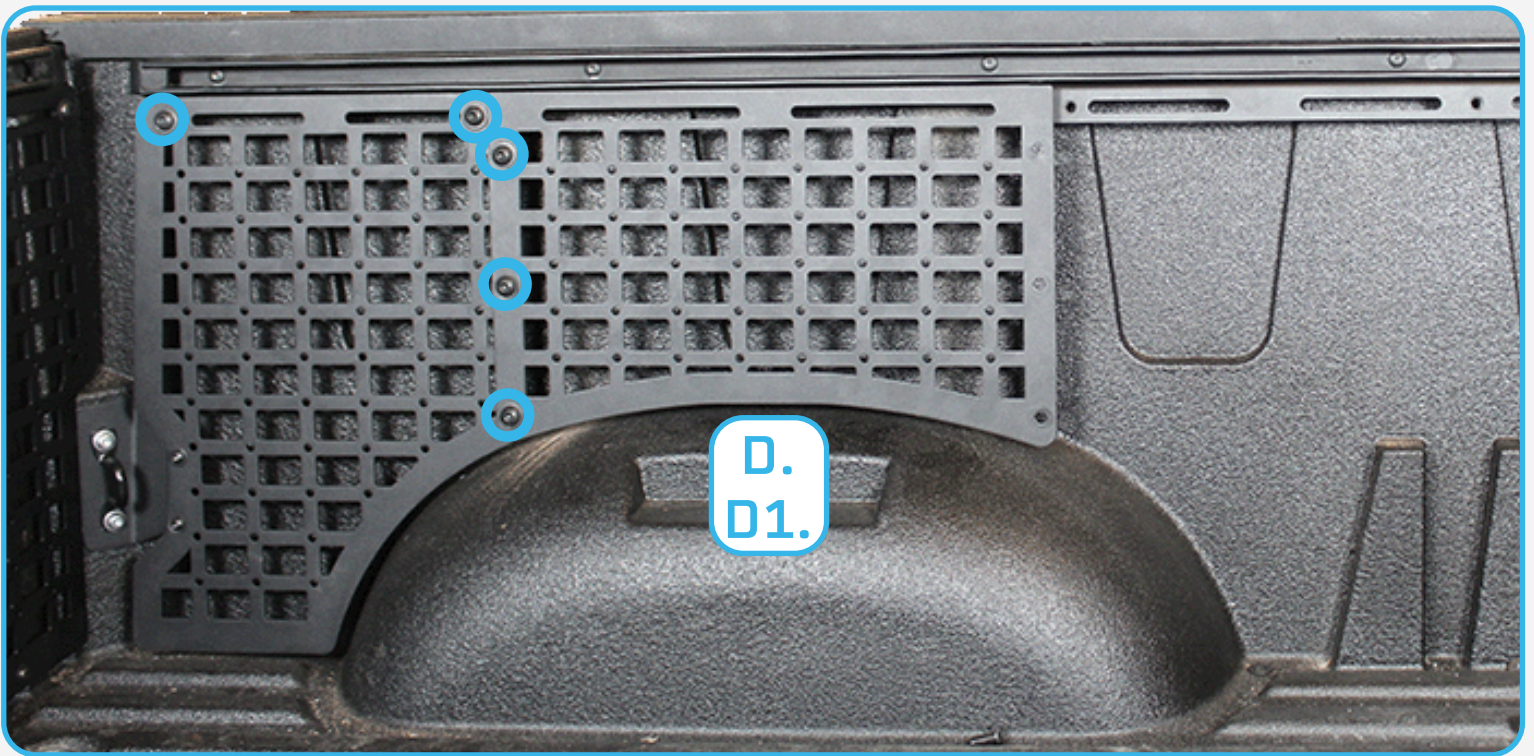
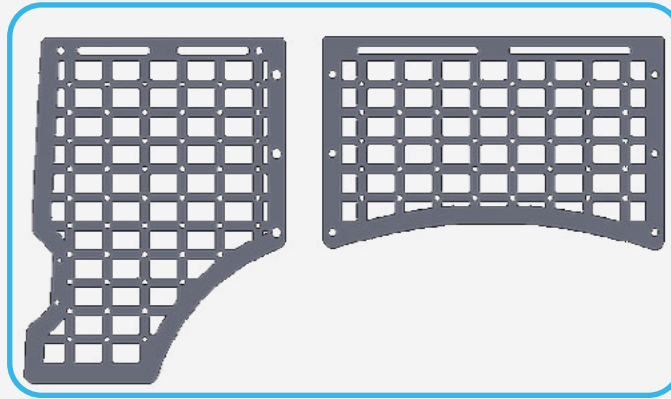

□ STEP 7

Install the rear side molle with the provided hardware (**C, C1**) with a (7/32 Hex).

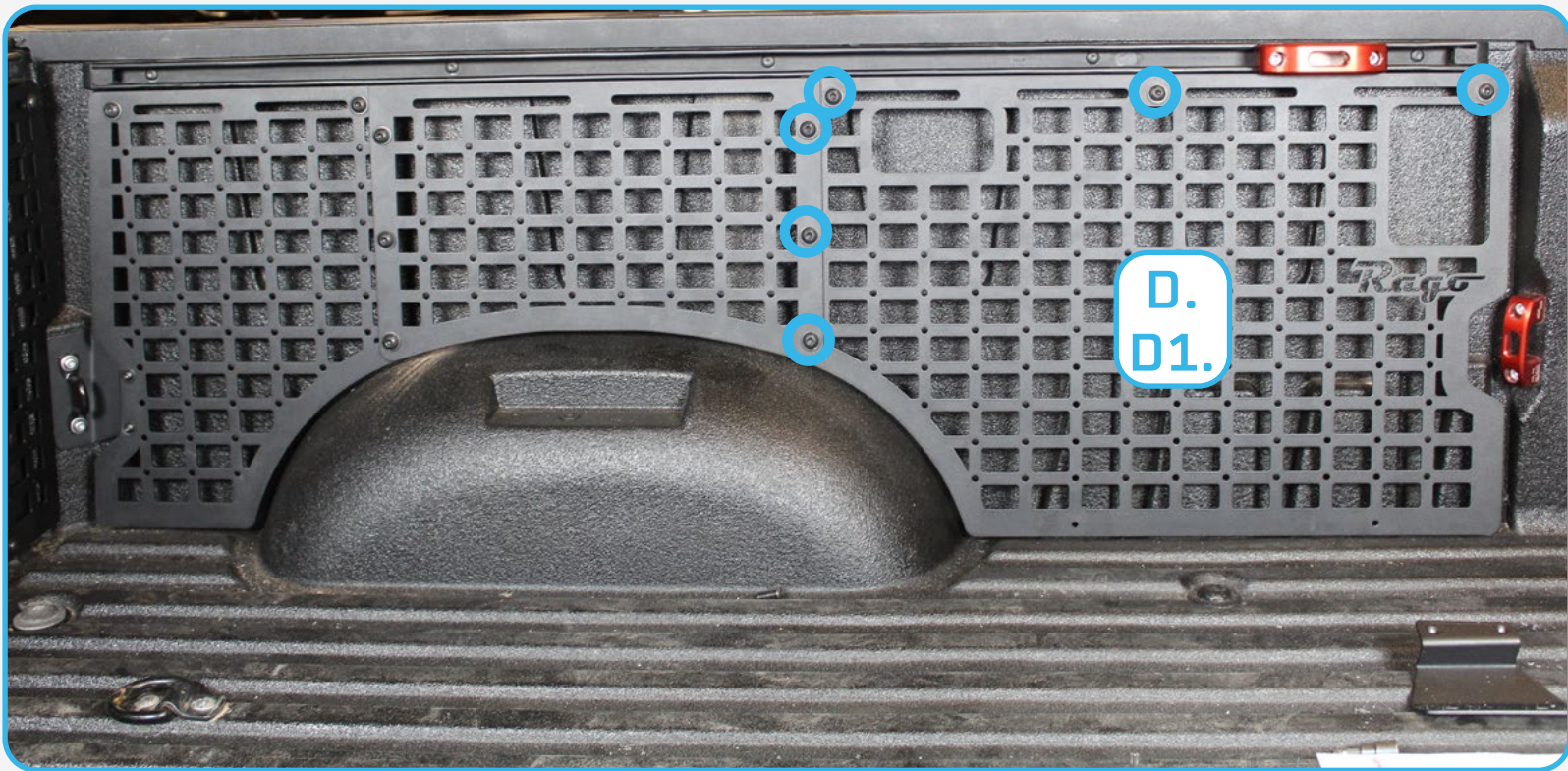
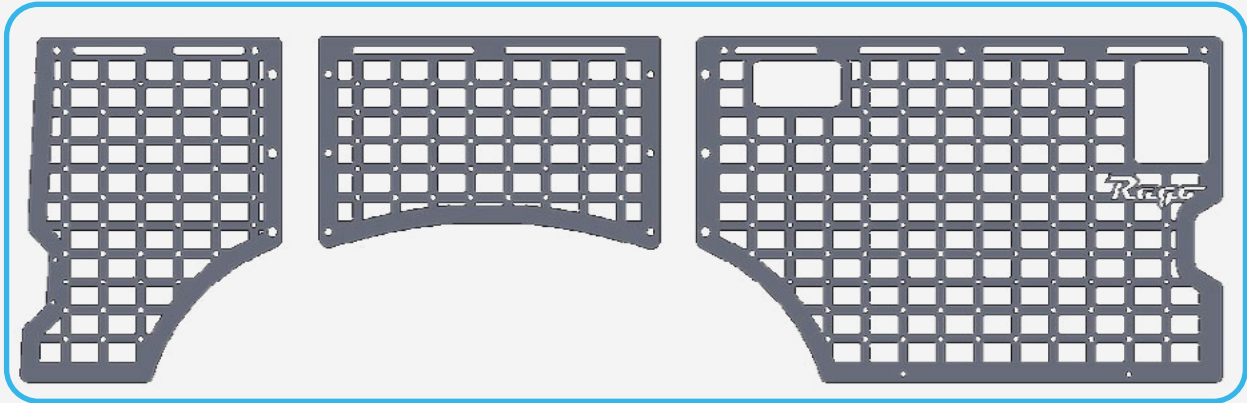

STEP 8

Mark the bottom holes and remove the rear side molle.

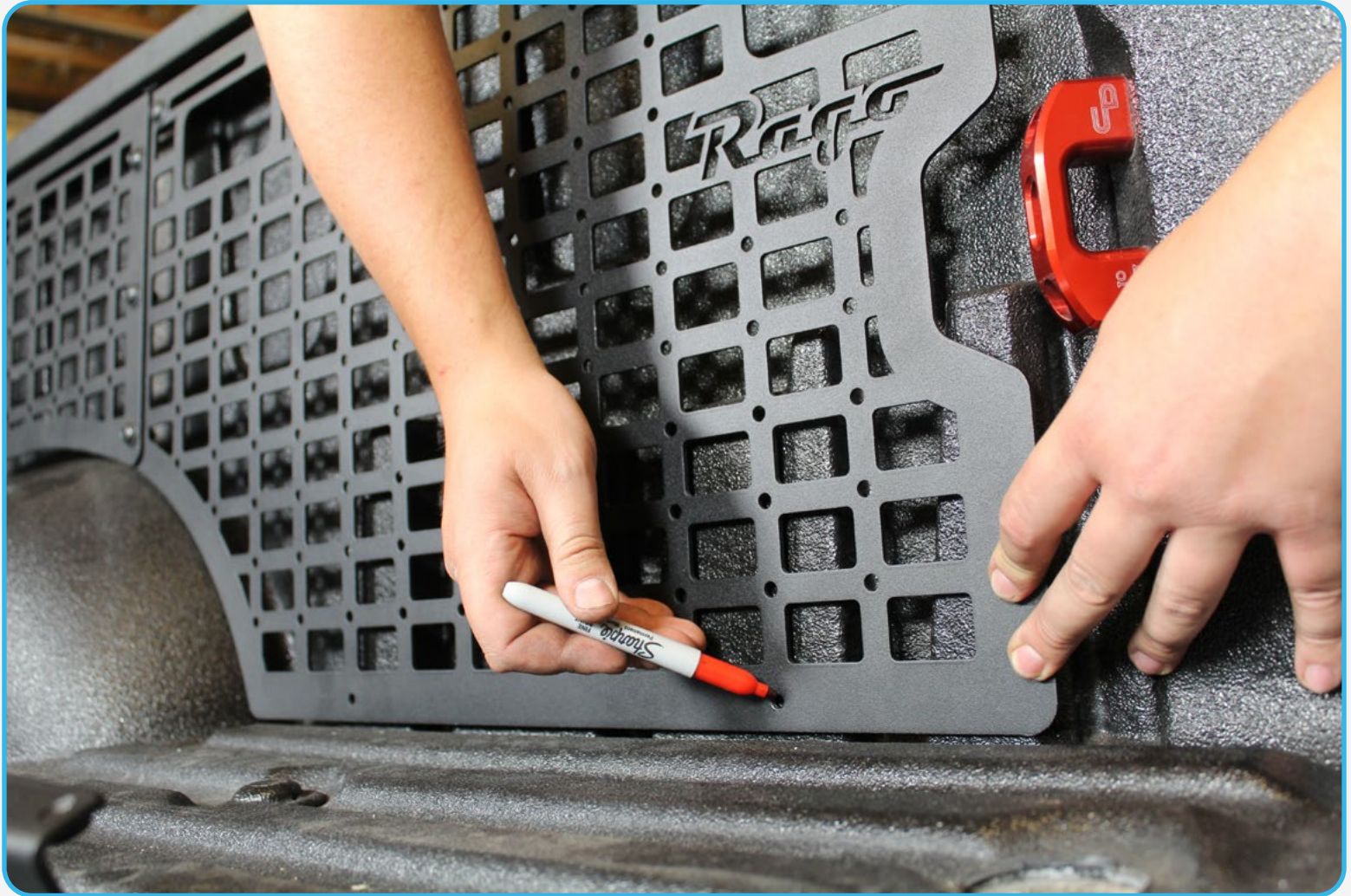

□ STEP 9

Drill a 7/16 hole using a (Uni-Bit) and install the provided rivet nuts (A3) with a (Rivet nut tool). (If you do not have a rivet nut tool refer to **step 10**)

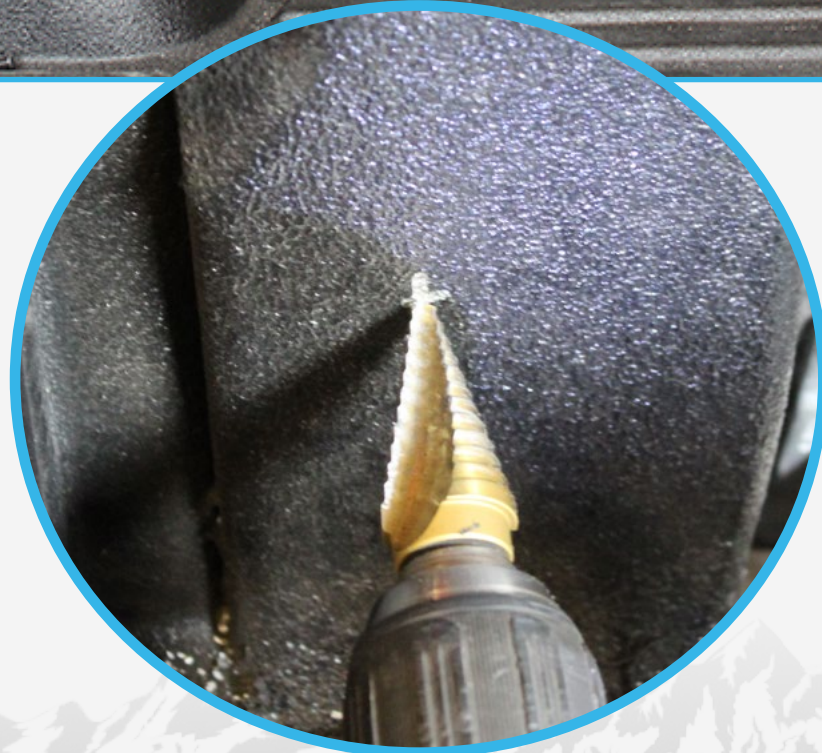
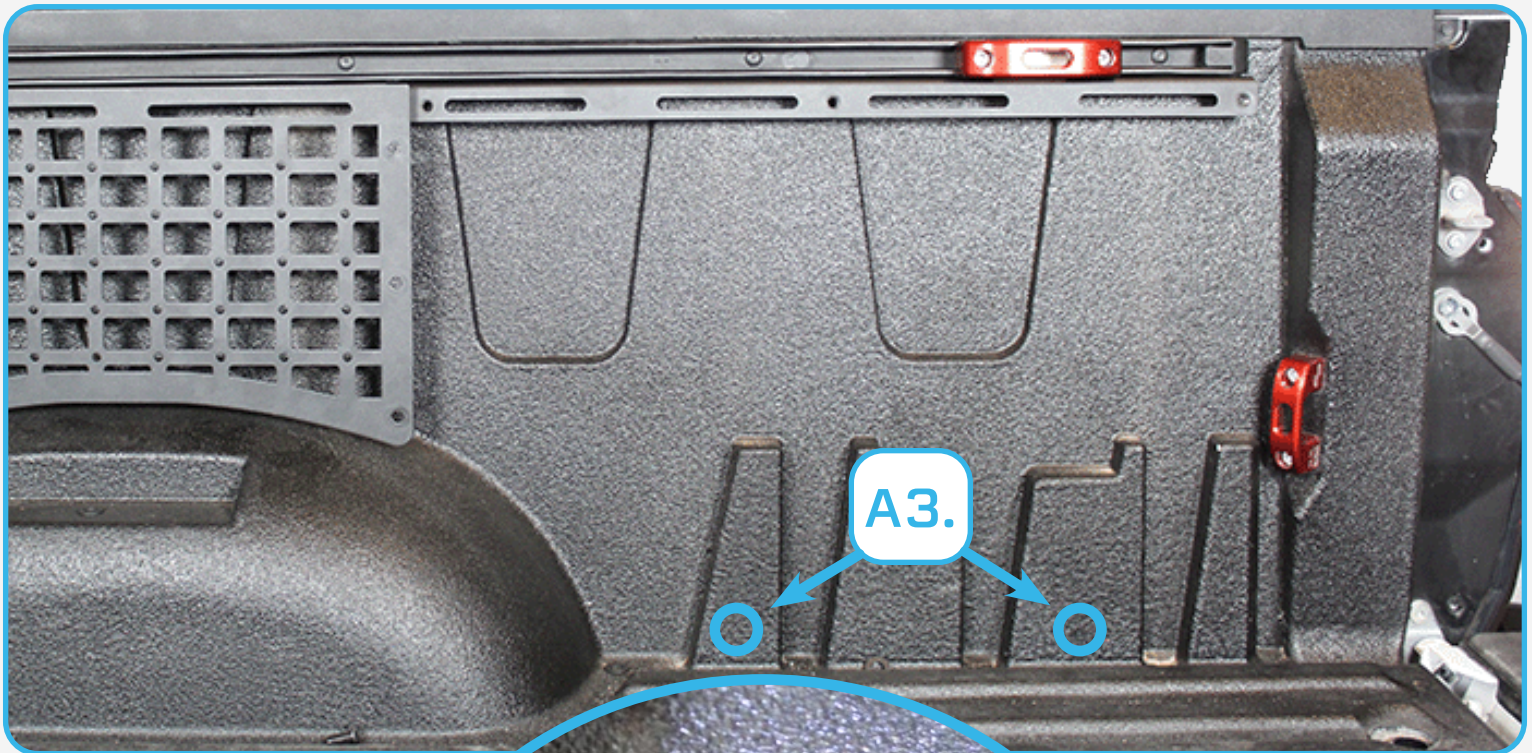

□ STEP 10

If you do not have a rivet nut tool, use a 1/4-20 x 3/4 hex head bolt, a 1/4 washer, and a 3/8 nut to install the rivet nuts **(B)**. Tighten using a (9/16 wrench) and a (7/16 socket) on a impact. **(Hardware not included)**

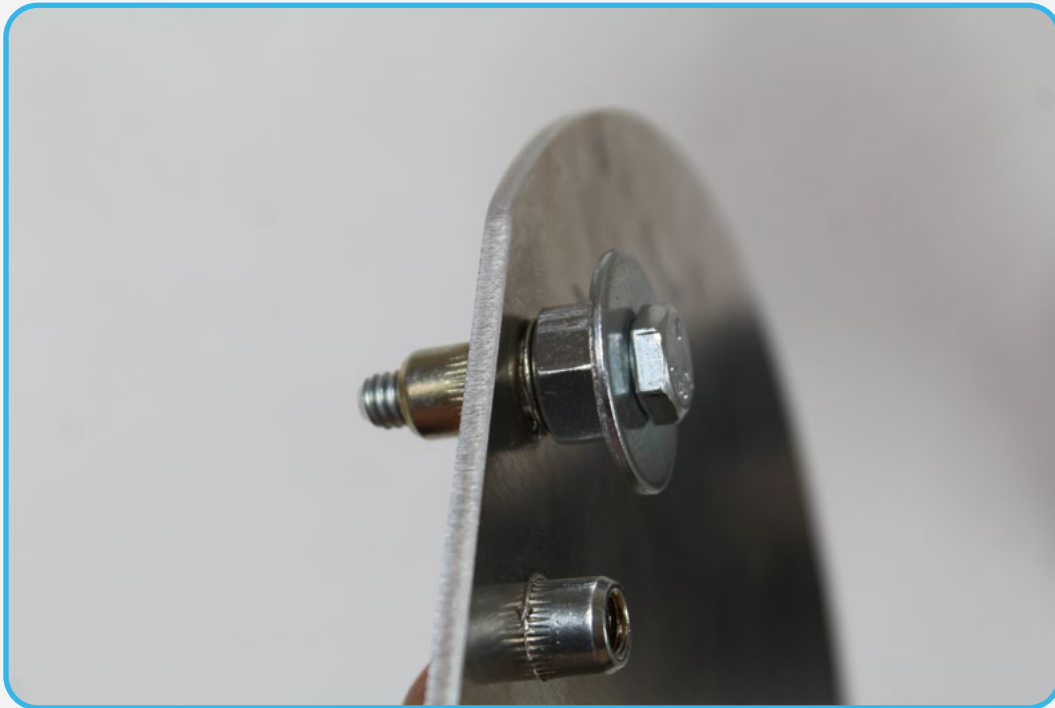

□ STEP 11

Re-install the rear side molle and install the bottom bolts with the provided hardware (**A1, A2**) and the Spacer (**B**) behind the molle panel with the Self-Retaining washer (**C**) to hold the spacer to the bolt as shown below.

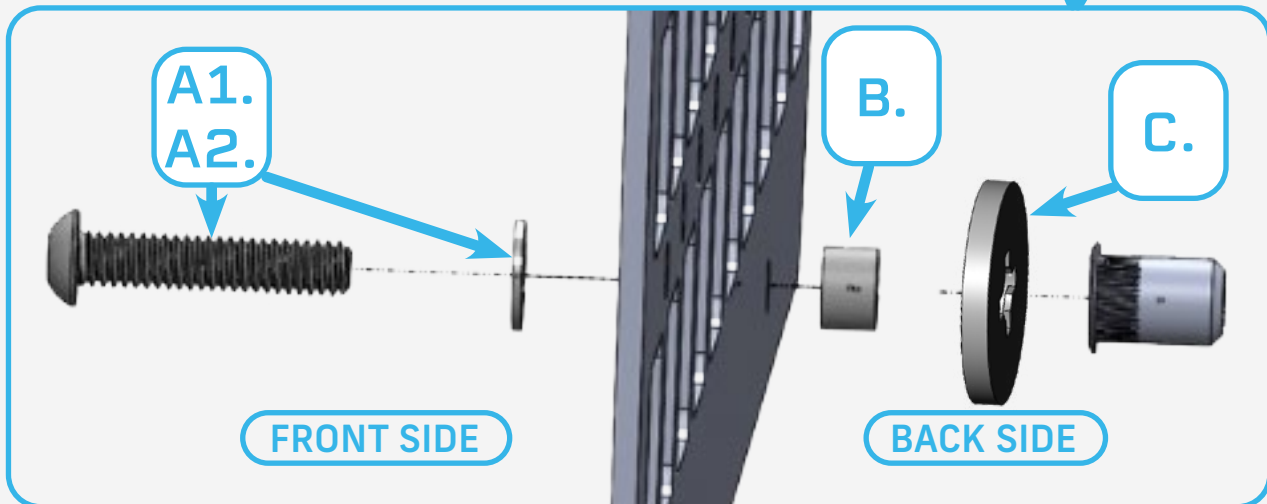
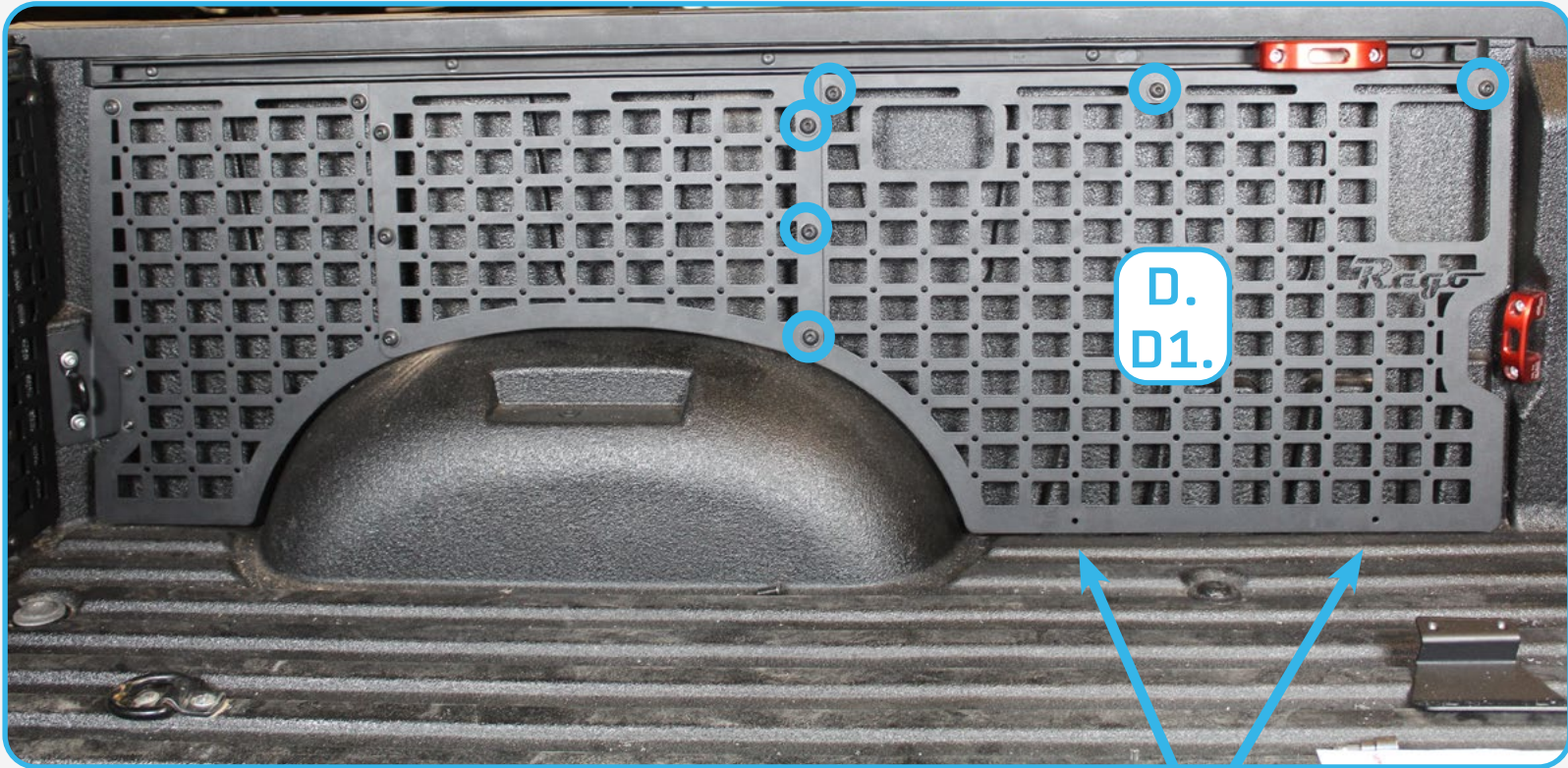

STEP 12

Double check all hardware and fitment for security.

Enjoy your new Rago Bed Side Molle.

